

# MARTIN 2

- PL** INSTRUKCJA MONTAŻU
- CZ** NÁVOD K MONTÁŽI
- D** MONTAGEANLEITUNG
- GB** ASSEMBLY INSTRUCTIONS
- F** MODEL D'EMPLOI

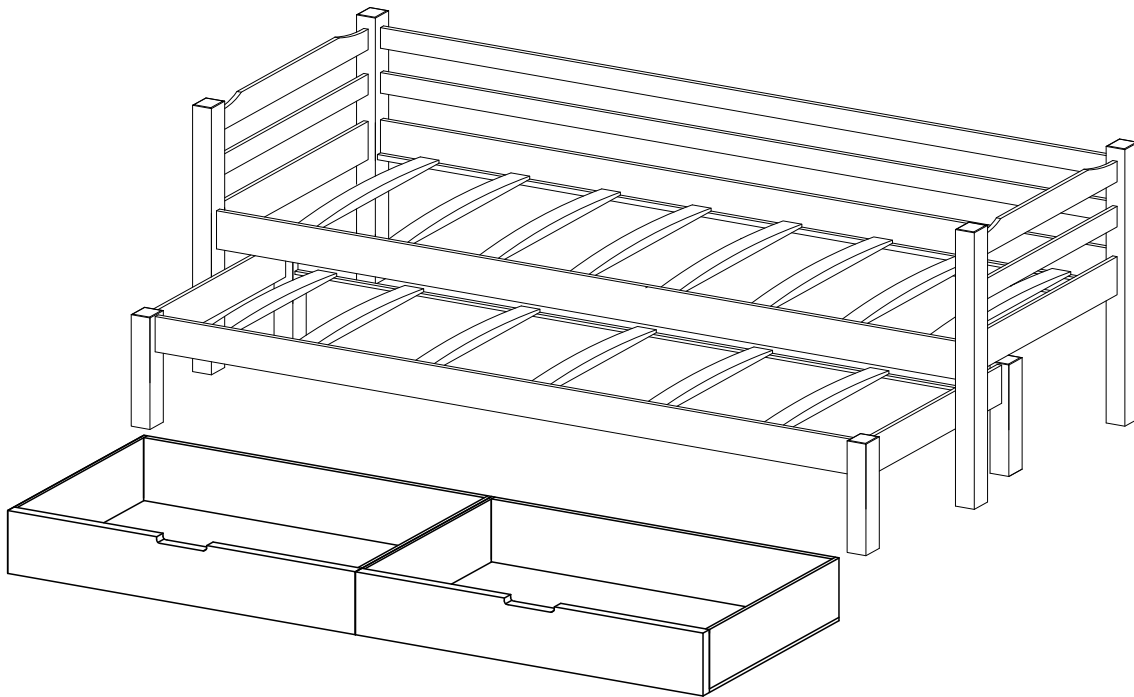
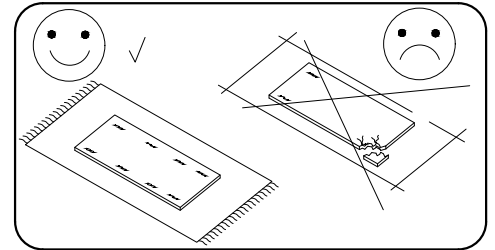
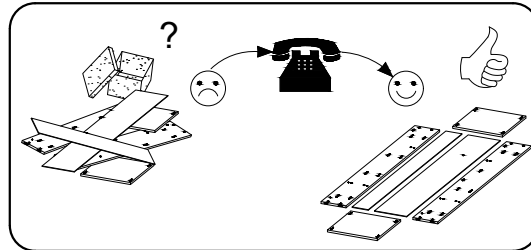
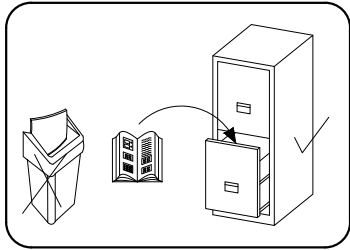
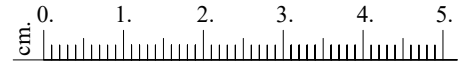
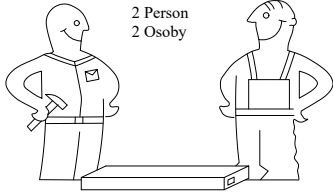

## Uwaga Upozornění Achtung Caution Attention

Czyszczenie należy wykonać wyłącznie za pomocą ściereczki lub lekko nawilżonego ręcznika. Nie stosować środków czyszczących do szorowania.

Čištění je nutné vykonávat výhradně pomocí utěrky nebo lehce navlženého ručníku. epoužívejte čisticí prostředky obsahující abrazivní částice







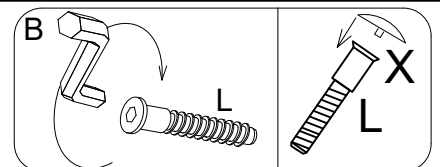
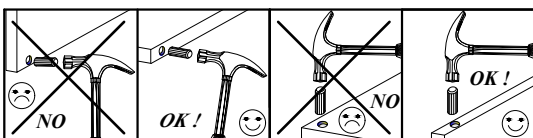





Bitte nur mit einem Staubtuch oder leicht feuchtem Lappen reinigen. Keine scheuerenden Putzmittel verwenden.

Please only clean with a duster or a damp cloth. Do not use any abrasive cleaners.

Le nettoyage se fait uniquement à l'aide d'un torchon ou d'une serviette légèrement mouillée.



# AKCESORIA / ACCESSORIES

Ø6.0x80	Ø - 10.0mm				3.5x16	7.0X50	3.5x35	Ø - 8.0mm			
											
F	E	C	X	B	G	L	J	T	N	R	M
16	16	24	20	1	44	4	12	16	8	1	2

## 1

KÓŁKA MONTOWAĆ TYLKO NA TYLNYCH NOGACH  
 WHEELS MOUNTED ONLY IN REAR LEGS  
 DIE RÄDER NUR HINTEN AN DEN BETTSTANGEN  
 ANSCHRAUBEN

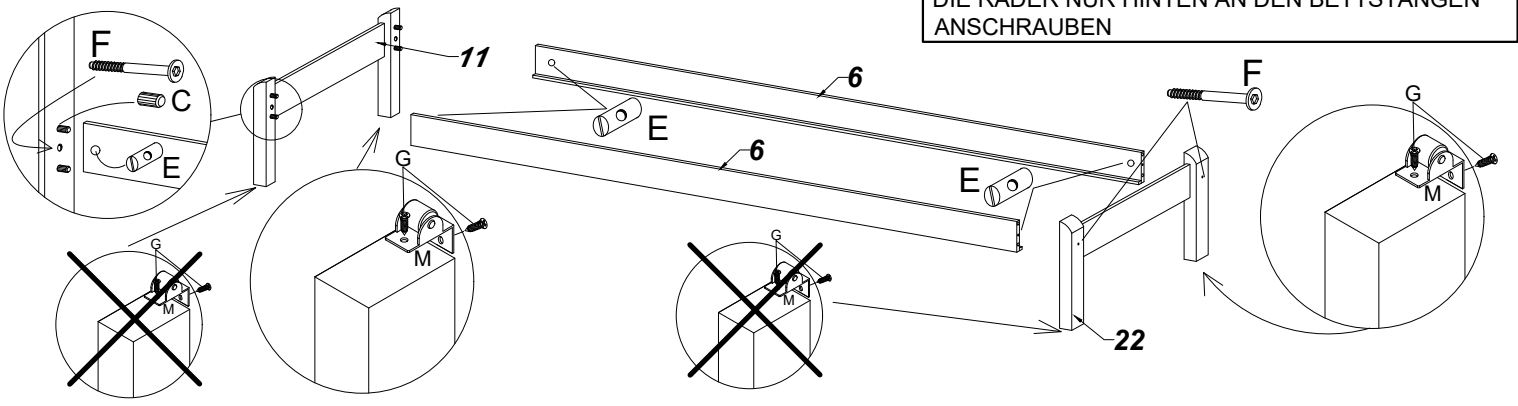

## 2

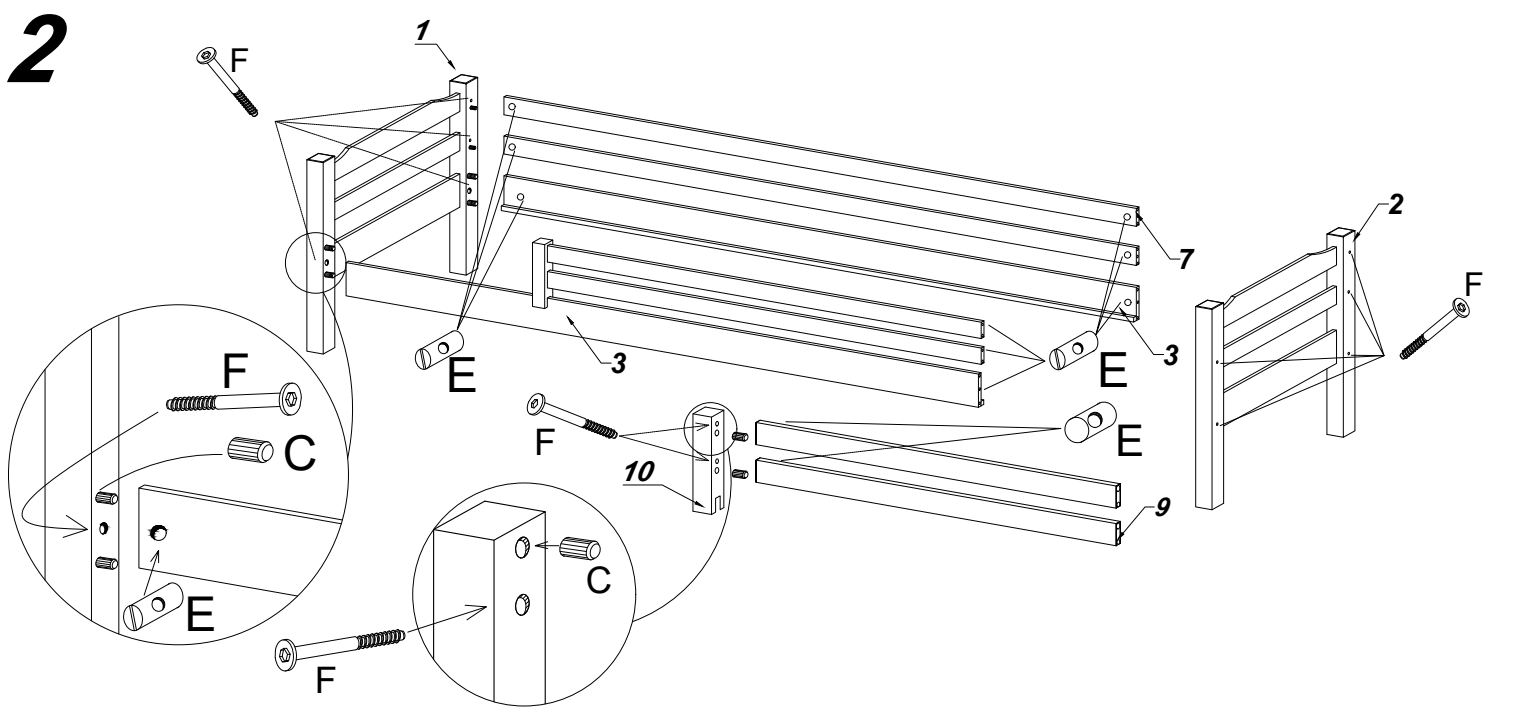

## 3

